



PACT100P/T110P

**PORTABLE AIR-CONDITIONER
CONDITIONNEUR D'AIR PORTATIF
SISTEMA DE AIRE ACONDICIONADO PORTÁTIL
CONDIZIONATORE D'ARIA**

Register this product on-line and receive a free trial issue of Cook's Illustrated.
Visit www.delonghi-registration.com.

Visit www.delonghi.com for a list of service centers near you. (U.S. and Canada Only)

Enregistrez ce produit en ligne et recevez un numéro gratuit de Cook's Illustrated.

Visitez www.delonghi-registration.com.

Visitez www.delonghi.com pour y voir une liste des centres de réparation proches de chez vous.
(É.-U. et Canada uniquement)

Registre este producto en línea y reciba un ejemplar gratis de Cook's Illustrated.

Visite www.delonghi-registration.com.

Visite www.delonghi.com para ver la lista de centros de servicios cercanos a usted. (Solamente en los Estados Unidos y Canada)

Registra questo prodotto "on-line" per ricevere una copia omaggio della rivista.

Visita www.delonghi-registration.com.

Visita www.delonghi.com per una lista dei centri di servizio a te più vicini. (Solo negli Stati Uniti e Canada)

Instructions for use

Keep these instructions

Mode d'emploi

Conservez cette notice

Instrucciones para el uso

Repase y guarde estas instrucciones

Istruzioni per l'uso

Leggere e conservare queste istruzioni

ELECTRICAL SPECIFICATIONS 115V ~ 60Hz

DONNEES ELECTRIQUES 115V~60Hz

CARACTERISTICAS ELECTRICAS 115V ~ 60Hz

CARATTERISTICHE ELETTRICHE 115V~60Hz

DeLonghi

PARTS AND ACCESSORIES • PIÈCES ET ACCESSOIRES •
PARTES Y ACCESORIOS • PARTI E ACCESSORI

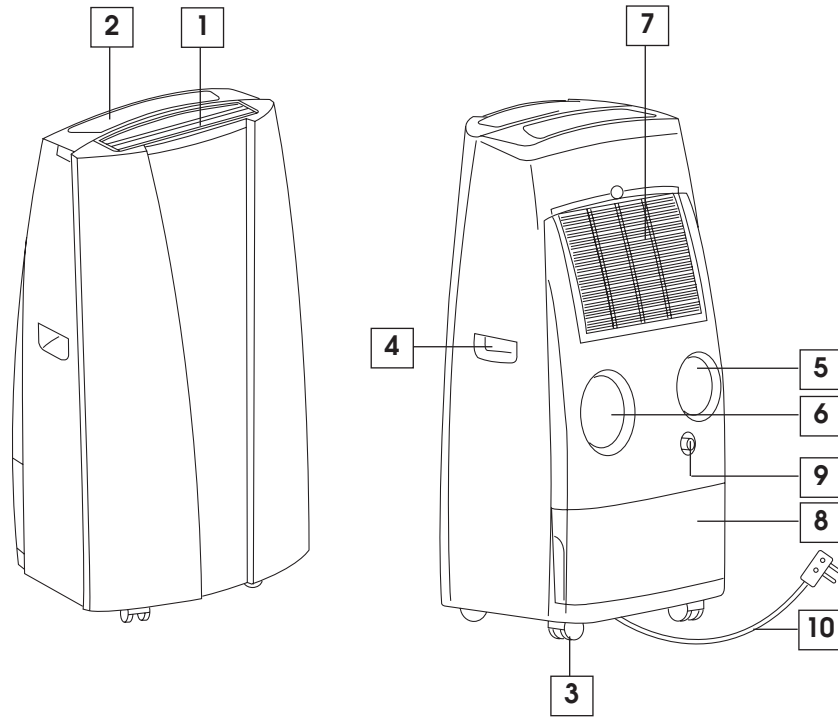

• See description on page 3 for english
• Véase descripción a la pág 37 para español

• Voir description à la page 20 pour le Français
• Vedi descrizione a pagina 54 per l'italiano

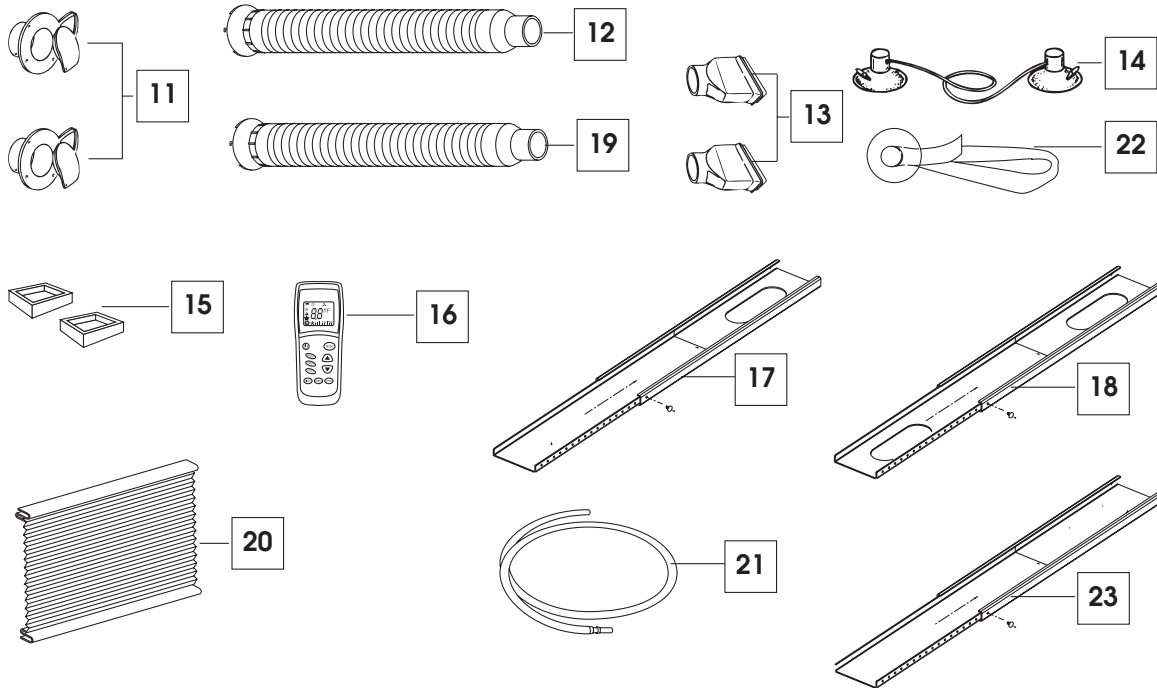

IMPORTANT SAFEGUARDS

- Use this appliance only as described in this instruction manual. As with any electrical appliance, the instructions aim to cover as many eventualities as possible.
Caution and common sense should be used when operating and installing this air conditioner.
- This appliance has been manufactured to cool and dehumidify domestic environments and should not be used for other purposes.
- It is dangerous to alter or modify the unit's characteristics in any way.
- The appliance must be installed in line with the relevant national legislation.
- Should repairs be necessary, contact the nearest authorized De'Longhi Repair Service Center. Unauthorized De'Longhi servicing can be dangerous.
- This appliance is to be used by adults only; keep away from children.
- In the case that the power cord becomes damaged, this must be substituted only by specialized personnel authorized by the manufacturer.
- Always ensure the appliance is grounded. If you have any doubts check with a qualified electrician.
- We strongly discourage the use of an extension cord due to potential safety hazards. For temporary situations, use only CSA certified and UL Listed 3-wire grounded extension cord, rated 15 A, 125 V.
- Before cleaning or maintenance operations, always unplug the unit from the outlet.
- Do not pull on or place strain on the power cord when moving the appliance.
- The appliance should not be installed where the atmosphere may contain combustible gases, oil or sulphur, or near heat sources.
- Do not rest hot or heavy objects on the appliance.
- Clean the filters at least once a week.
- Avoid using heaters near the unit.
- The unit should be transported in a vertical position. If this is not possible secure the unit at an angle, do not lie it horizontally.
- Before transporting the appliance, completely empty the internal circuit of water by pressing the **MODE** and **SPEED** buttons simultaneously for a few seconds without removing the tank. Then empty the tank.
- After transportation, wait at least 8 hours before switching the unit on.
- Use the appliance as described in this instruction manual only. As with all electrical equipment, whilst the instructions aim to cover as many eventualities as possible, caution and common sense should be applied when operating and installing this appliance.
- At the end of its working life, consign the appliance to a specialist collection center.
- The packaging materials can be recycled. It is recommended to place them in the special containers for differentiated waste collection.

SAVE THESE INSTRUCTIONS

DESCRIPTION

- | | |
|--|--|
| 1 air outlet grille | 13 2 window outlets |
| 2 control panel | 14 suction pads (only on some models) |
| 3 castors | 15 castor locks |
| 4 handles | 16 remote control |
| 5 air exhaust hose housing | 17 single hole window bracket with locking pins |
| 6 condenser air intake grille | 18 double holes window bracket with locking pins |
| 7 evaporator air intake grille with dust filter | 19 air inlet to intake hose |
| 8 condensation tank | 20 3M® electrostatic filter |
| 9 continuous condensation drain connection | 21 continuous drain hose with coupling |
| 10 power cable | 22 suction pads with velcro (only on some models) |
| 11 2 flange caps | 23 Window bracket without holes (only on some models) |
| 12 air exhaust hose | |

What are the Pinguino portable air conditioners?

During the summer, optimum comfort is achieved with a temperature between 75 and 81°F (24 and 27°C) with a relative humidity of about 50%.

An air conditioning unit removes excess moisture and heat from the room where it is located. Compared with window units, portable air conditioning units have the advantage that they can be moved from one room to another in the home or be transported from one building to another.

Hot air from the room is passed through a coil cooled by refrigerant gas.

Excess heat and moisture are removed before the air is re-emitted into the room.

In single unit models (as this model), a small part of this air is used to cool the refrigerant gas and the hot and moist air is discharged outside..



Installing your portable air-conditioner

ELECTRICAL CONNECTIONS

Before plugging the appliance into the electrical socket, check that:

- the power supply corresponds to the value indicated on the rating plate on the back of the appliance;
- the socket and electrical circuit are adequate for the appliance;
- the socket matches the plug. If this is not the case, have the plug replaced;
- the socket is adequately grounded.

Failure to follow these important safety instructions absolves the manufacturer of all liability.

The power cord must be replaced by a qualified professional only.

The instructions below will enable you to prepare your air conditioning unit for operation as efficiently as possible.

Before use, make sure the air intake and outlet grilles are unobstructed.

NON PERMANENT INSTALLATION

Just a few simple steps and your comfort is ensured with Pinguino:

- Fit the air exhaust hose (12) in the housing (5) at the back of the appliance. Insert it as shown in figure A.

In order to improve the performance of the appliance in air conditioning and boost (super-conditioning) modes, you can also fit the intake hose accessory (19) in its housing in the back of the appliance as shown in figure A1. This step is optional.

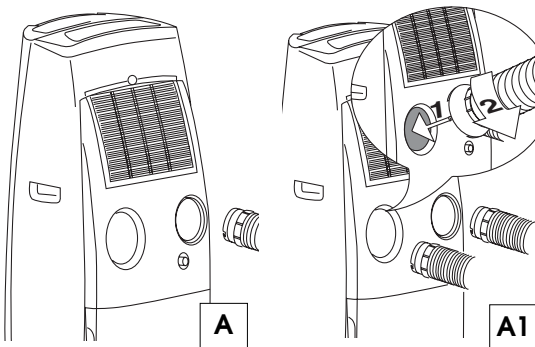

- Fit the window outlets (13) to the end of the hose (12/19).
- Place the air conditioning unit near a window or French window.
- Make sure the air exhaust hose is unobstructed.

Keep air hoses as short and free of curves as possible to avoid constrictions.

Sash window

For optimum results:

- If you have a sash window, place the bracket (17) or (18) according to your needs, on the window sill, extend the bracket fully within the window frame, fix the

bracket by using the locking pin then lower the window onto the bracket. Insert the window outlet (13) of the exhaust hose (12) into the slot, then connect the hose to the air conditioner (fig. B and B1).

Thanks to the locking pins, it's possible to use the window bracket also for sliding windows. Position the hole of the bracket so to allow a correct installation of the exhaust hose.

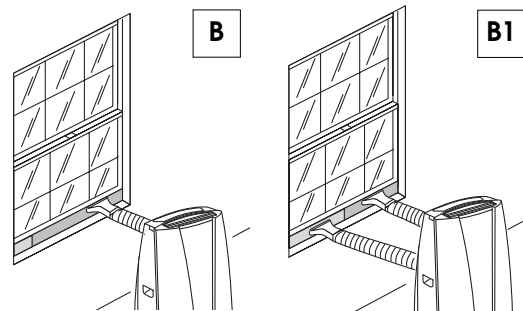

If the windows are large, use the window bar without holes (23) (if provided) to cover your window aperture, extending it to the required length, then blocking it with the locking pins supplied (see figure below). Make sure you do not cover the hole or holes for the window outlet.

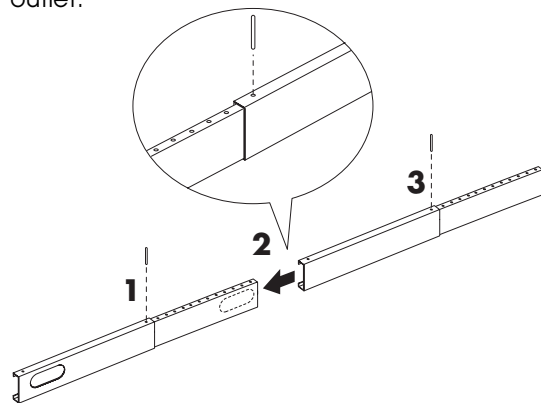

Installing your portable air-conditioner

Double window

Open the double window slightly and position the window outlet (13) . Use the suction pads (14) or (22) (depending on model) to hold the two parts of the window together (fig. D and D1).

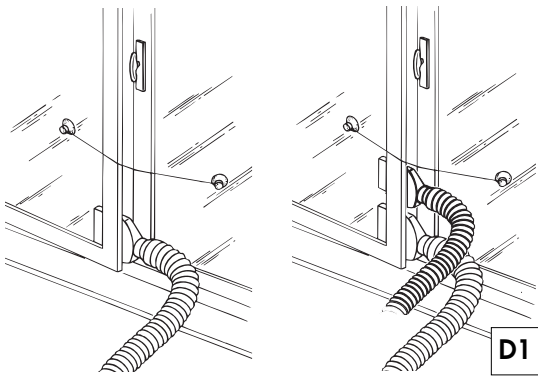
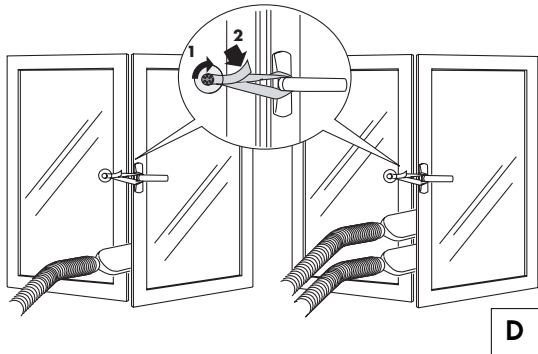

SEMI-PERMANENT INSTALLATION

If required, the Pinguino can also be installed semi-permanently (Fig. E and E1).

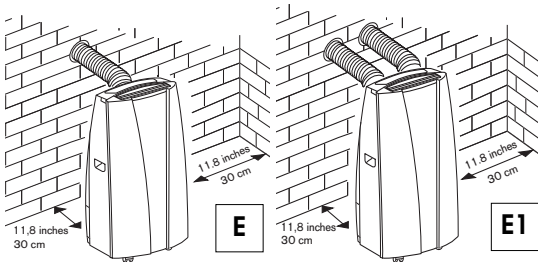

Proceed as follows:

- Drill a hole in an outside wall or through a window pane. Respect the height and dimensions of the hole (s) given in figures F and G.

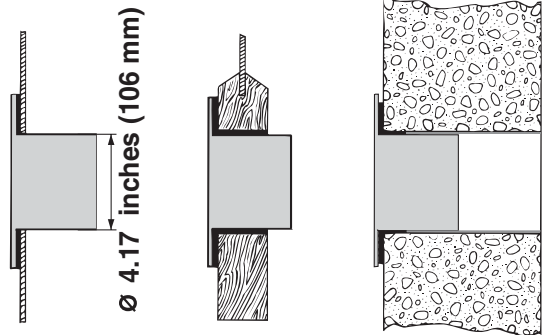

in the window pane

in the wooden kick-board of a French window

in the wall: you are recommended to insulate the section of wall using suitable insulation.

F

Keep the air hoses as short and free of curves as possible to avoid constrictions.

- Fit the flange accessory (11) provided in the hole.
- Fit the hose (12/19) in the housing at the back of the appliance (fig. A / A1 page 5).
- Fit the end of the hose (12/19) to the flange (11) as shown in fig. G.

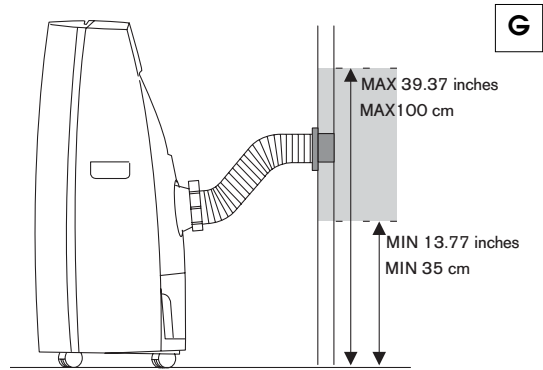

When the hose (12/19) is not fitted, the drilled hole can be closed with the flange cap (11).

NOTE.

When installing the air conditioning unit semi-permanently, you should leave a door slightly open as little as 1/2 inches (1 cm) to guarantee correct ventilation.

Control panel

THE CONTROL PANEL

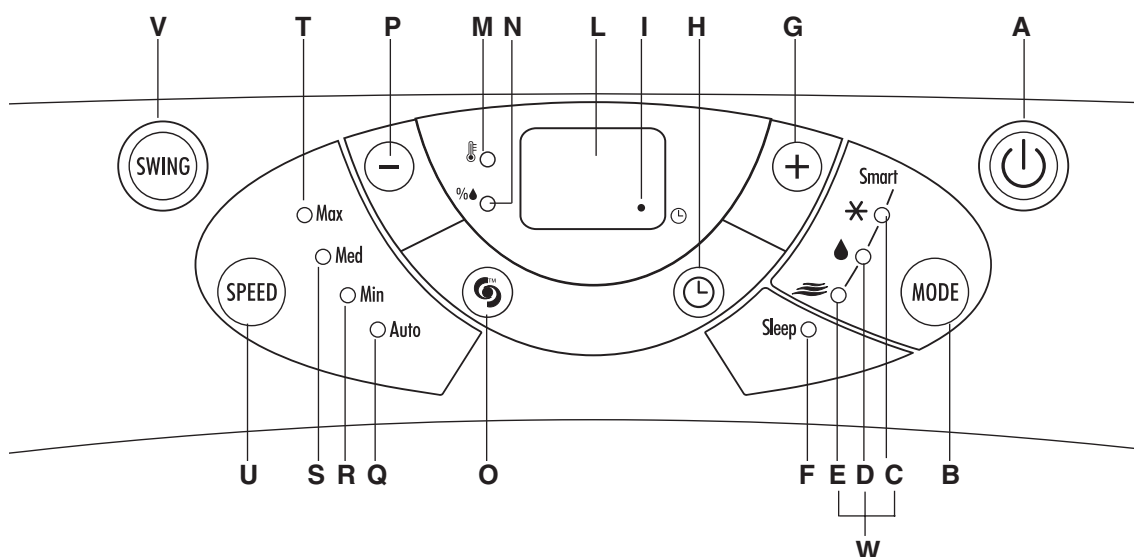

DESCRIPTION OF THE CONTROL PANEL

- A** ON/Stand-by button
- B** MODE selection button
Air conditioning, dehumidifying, air purifying/fan, Smart.
- C** Air conditioning mode indicator light
- D** Dehumidifying mode indicator light
- E** Fan mode with air filtration indicator light
- F** "Sleep" function indicator light (can be selected from remote control only)
- G** Increase temperature/humidity/programmed operating time button
- H** Timer button
- I** Timer in operation indicator light
- L** Display visualising temperature/humidity values set and operating time
- M** Temperature indicator light
- N** Humidity indicator light
- O** BOOST button
- P** Reduce temperature/humidity/programmed operating time button
- Q/R/S/T** AUTO mode and Fan speed indicator lights
- U** Fan SPEED selection button
- V** Grille flaps SWING button
- W** "Smart" function (indicator lights C/D/E)

Note: The **SWING** button (**V**) moves the grille flaps to distribute the cool air uniformly in the room. When the swing button (**V**) is pressed once and the flaps have begun moving alternately forwards and backwards, pressing the button again will lock the flaps in their current position. Pressing the button again will restart the flaps moving forwards and backwards. When the appliance is turned off, they will close irrespective of their position.

Operation

Depending on the model, the temperature on the display is shown in °C or °F. However, the illustrations in the manual give the values in °F.

TURNING THE APPLIANCE ON

Plug the appliance into the socket. Two lines appear on the display indicating that the appliance is in standby. You can control the appliance with the remote control (see page 11) or with the control panel.



OPERATION WITH CONTROL PANEL

Press the **ON/STAND BY** button (A). When turned on, the air conditioning unit starts operating in the same mode as when it was turned off. Press the **MODE** button (B) until the indicator light corresponding to the required mode lights up:

Indicator light (C): ✖ air-conditioning mode

Indicator light (D): 💧 dehumidifying mode

Indicator light (E) : 🌊 fan mode with air filtration

Indicator light (C-D-E) together: smart mode

After selection, the flaps open at a preset angle.

When the air conditioner is turned off, the flaps will close.

AIR-CONDITIONING MODE

Ideal for hot humid weather when you need to cool and dehumidify the room.

To set the operation of the appliance correctly, press the "+" (G) or "-" (P) buttons until the desired temperature is displayed.

Then select the fan speed by pressing the **SPEED** button (U) until the indicator light corresponding to the required fan speed lights up.

MAX: the air conditioning unit operates at maximum to reach the required temperature as rapidly as possible

MED: reduces noise levels but still maintains a good level of comfort

MIN: for silent operation

AUTO: the appliance automatically selects the most suitable fan speed in relation to the temperature set on the digital display

The most suitable temperature for the room during the summer varies from 75° - 81° F (24 to 27°C).

You are recommended, however, not to set a temperature excessively lower than the outside temperature.



DEHUMIDIFYING ????

Ideal for reducing humidity in spring and autumn, during rainy spells or in damp rooms. Place the appliance in the room without fitting the air exhaust hose (12) and the intake hose (19). After selecting dehumidifying mode, the light (D) comes on. Press the "+" (G) or "-" (P) buttons until the required humidity level is displayed. At the same time, the Auto fan light (Q) comes on as the appliance automatically selects the most appropriate speed. Water is removed from the air and collected in the condensation tank (8) at the back of the air conditioner.



Operation

When full, the appliance shuts down and **FL** (full tank) appears on the display. The tank must be extracted and emptied (fig. **H**). Once emptied, replace the tank: the appliance starts up again. The continuous drain hose accessory (**21**) enables the condensation produced to be eliminated without requiring the tank to be emptied periodically. Fit the hose with the rapid coupling (**21**) as shown in fig. **I**.

Note: In order for the continuous drain function to operate correctly, make sure the accessory is fully connected to the coupling. To release, press the drain connection (**9**).

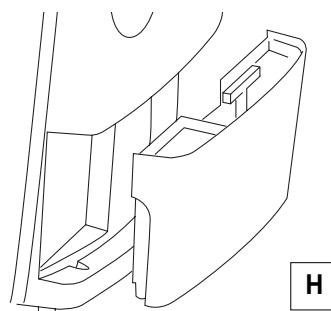

FAN MODE WITH AIR FILTRATION

Adjust fan speed by pressing the **SPEED** button (**U**) as described for the air-conditioning mode.

Remember that the higher the speed, the more air is filtered. If you select "**Min**" speed, less air is filtered, but the appliance is also less noisy. In this mode, **Auto** cannot be selected.

The fan speed selected will be displayed.

"3M Filtrete" air purifying filter

This is ideal for dusty rooms. In addition to removing dust, the 3M Filtrete™ electrostatic air purifying filter also captures the smallest impurities (down to 0.003 mm), such as cigarette smoke.

To use the air purifying filter:

- A)** Remove the evaporator air intake grille (**7**).
- B)** Remove the filter (**20**) from the packaging.
- C)** Use the two plastic edges to attach the filter to the tabs on the dust filter inside the intake grille.
- D)** Replace the grille on the appliance.

When removing the evaporator air intake grille (**7**), do not touch the evaporator's metallic wings because they are very sharp and could be dangerous.

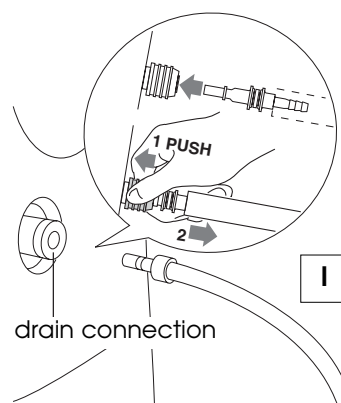

SMART MODE

In "SMART" mode the air conditioner unit decides the best way to operate, to guarantee maximum comfort.

Press the **MODE** button (**B**) repeatedly until all three indicator lights, (**C/D/E**), on the control panel come on. The word **Sm** appears on the display.

Note: in "SMART" mode, temperature is controlled automatically. However, if the required temperature has not yet been reached, it can be reduced or increased by a maximum of 4°F (approx. 2°C) by pressing the **▲ ▼** buttons on the remote control (see page 13).

The appliance will automatically set the operating mode (air conditioning or fan/air purifying) and optimum speed.

BOOST MODE

Press the **6** button (**O**) to set the "BOOST" mode.

In this mode, the appliance operates at maximum air conditioning power, rapidly cooling the room. The **bo** symbol is displayed and fan speed is at maximum.

AUTOMATIC SLEEP MODE

This mode can be activated by the remote control only.

For more information, see the paragraph "SLEEP FUNCTION" on the remote control (page 14).

When this function is activated, the **SLEEP** indicator light (**F**) on the control panel comes on.

Operation

SETTING THE TIMER

The timer can be used to delay appliance start up or shut down. This avoids wasting electricity by optimizing operating periods.

How to program delayed start up

- Plug the appliance into a socket and press the **ON/STAND BY (A)** button, then select the required operating mode and other settings (temperature, fan speed, etc).
- Press the **ON/STAND BY (A)** button again to place the appliance in standby mode.
- Press the timer button **(H)**. The two center segments flash on the display.
- Use the "+" **(G)** or "-" **(P)** buttons to set the number of hours delay before the appliance comes on. The setting is increased or decreased by an hour at a time; however, when the buttons are held down for more than two seconds, the time runs rapidly up to a maximum of 24 hours. Wait a few seconds for the data to be acquired.
- The indicator light **(I)** flashes until the appliance starts up.
- You can set the appliance to come on with a delay of up to 24 hours.
- To cancel the timer setting, press the timer button **(H)**, and use the "-" **(P)** button to set the time to "00". The indicator light **(I)** will stop flashing.

How to program delayed shut down

- Delayed shut down can be programmed in any operating mode.
- Press the timer button **(H)**. The two center segments flash on the display.
- Use the "+" **(G)** or "-" **(P)** button to set the number of hours delay before the appliance goes off.
The setting is increased or decreased by an hour at a time; however, when the buttons are held down for more than two seconds, the time runs rapidly up to a maximum of 24 hours. Wait a few seconds for the data to be acquired.
- The indicator light **(I)** flashes until the appliance shuts down.
- To cancel the timer setting, press the timer button **(H)**, and use the "-" **(P)** button to set the time to zero. The indicator light **(I)** will stop flashing.

The remote control

Depending on the model, the temperature on the display is shown in °C or °F. However, the illustrations in the manual give the values in °F.

THE REMOTE CONTROL

Inserting/replacing batteries (included)

- Remove the back cover (see figure).
- Insert two new batteries (not rechargeable) making sure the (+) and (-) are in the correct positions.
- Replace the back cover.

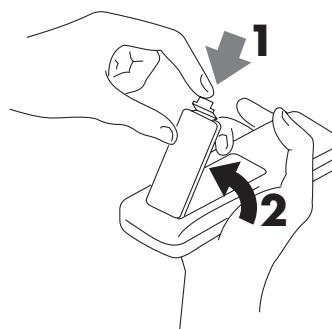

Note: Alkaline batteries should be used (LR03 AAA type).

Used batteries can be harmful to the environment, and should not be thrown out with household waste. Contact your local government to find out if they have a battery recycling program or how to dispose of used batteries.

Warning:

Do not mix old and new batteries. Do not mix alkaline, standard (carbon-zinc) or rechargeable (nickel-cadmium) batteries.

Do not dispose of batteries in fire: batteries may explode or leak.

If the remote control is not be used for a certain length of time, remove the batteries.

CORRECT USE

- Aim the remote control at the signal receiver on the air-conditioner.
- Maximum distance: around 23 ft. (7 meters) (without obstacles between the remote control and the receiver).
- The remote control should be handled with extreme care: without dropping it, without exposing it to direct sunlight or near sources of heat.

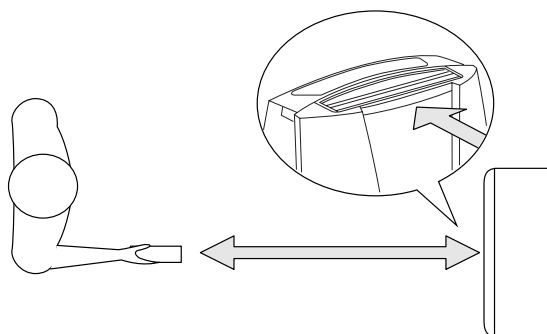

Description of the remote control

THE REMOTE CONTROL

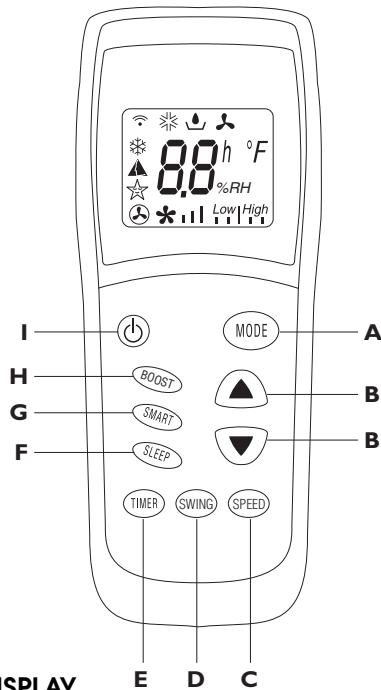

THE DISPLAY

- Signal transmission
- Air-conditioning indicator
- Dehumidifying indicator
- Air filtration indicator
- BOOST indicator
- SMART indicator
- SLEEP indicator
- Automatic fan speed
- High fan speed
- Medium fan speed
- Low fan speed

Used to set the temperature in SMART mode (see page 14 for further information)

A. MODE button

Selects the operating mode (air conditioning, dehumidification, air filtration, Smart).

B. Buttons for SETTING THE ROOM TEMPERATURE

Set room temperature or program the timer.

C. SPEED button

Sets fan speed to automatic, high, medium or low in sequence.

D. SWING button

Activates the motorized lowers.

E. TIMER button

Sets or cancels the timer.

F. SLEEP button (☆)

Sets or cancels the automatic SLEEP function.

G. SMART button (▲)

When this button is pressed, the appliance automatically establishes the most suitable operating mode for maximum comfort.

H. BOOST button (*)

Starts or stops rapid cooling. In the rapid cooling mode, the fan operates at high speed with the temperature automatically set to 64°F (18°C).





I. ON/STAND BY button

Press this button to turn the appliance on and in stand by.

Note: the settings are displayed even when the air conditioner is in stand by.

Remote control functions



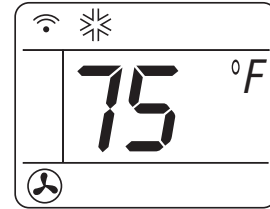

AIR-CONDITIONING MODE

- Press the  button (I) to turn the appliance on.
- The  symbol flashes on the display and a “beep” indicates that the air-conditioning unit is on.
- Press the **MODE** button (A) a number of times until the air-conditioning symbol  appears on the display.
- Now set the temperature using the   buttons.
- To select fan speed, press the **SPEED** button (C) repeatedly until the required fan speed is selected (automatic, high, medium, low).

NB: in air-conditioning mode, the appliance automatically removes excess moisture from the atmosphere.



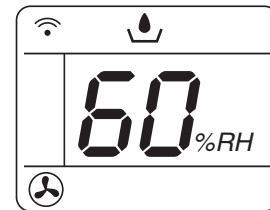

DEHUMIDIFYING

- Activate this function when humidity is high.
- Press the  button (I) to turn the appliance on. The  symbol flashes on the display and a “beep” indicates that the air conditioner unit is on.
- Press the **MODE** button (A) a number of times until the dehumidifying symbol  appears on the display.
- Set the required humidity level using the   buttons.
- In dehumidifying mode, fan speed is selected by the appliance automatically.
- Place the appliance in the room without fitting the air exhaust hose.



FAN MODE WITH AIR FILTRATION

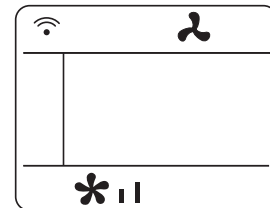

In humid but not particularly hot days, the fan function alone may be adequate.

- Press the  button (I) to turn the appliance on. The  symbol flashes on the display and a “beep” indicates that the air-conditioning unit is on.
- Press the **MODE** button (A) a number of times until the fan symbol  appears on the display.
- Once purifying mode has been selected, press the **SPEED** button (C) until the required speed is reached (low, medium, high).



BOOST FUNCTION

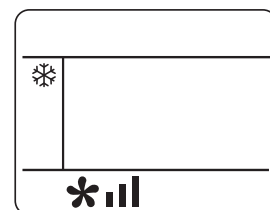

“BOOST” function is used to obtain rapid cooling. The fan is set to high speed and the temperature is automatically set to 64°F (18°C). To select “BOOST” function, proceed as follows:

- Press the  button (I) to turn the appliance on. The symbol  flashes on the display and a “beep” indicates that the air-conditioning unit is on.
- Press the **BOOST** button (H) to set the function. The symbol  is displayed.
- To go back to the previous mode, press the **BOOST** button again. With the “BOOST” function activated, the display on the control panel shows *bo*.



SMART FUNCTION

In “SMART” function, the air-conditioning unit decides the best way to operate to guarantee maximum comfort.

- Press the  button (I) to turn the appliance on. The symbol  flashes on the display and a “beep” indicates that the air-conditioning unit is on.
- Press the **SMART** button (G). The appliance functions automati-

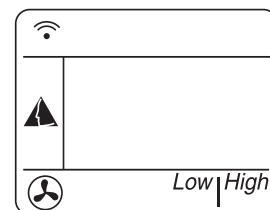

Remote control functions

cally and the ▲ symbol appears on the display.

Note: in "SMART" function, the temperature is controlled automatically. However, if the required temperature has not yet been reached, it can be reduced or increased by a maximum of 4°F (approx. 2°C) by pressing the ▲ ▼ buttons.



The appliance automatically establishes the operating mode (air-conditioning, fan, heating) and the optimum fan speed.

With the "SMART" function activated the display on the control panel shows **57** and the three indicator lights (C/D/E) will come on.

SLEEP FUNCTION

The automatic "SLEEP" function is ideal for the night-time as it enables operation of the air-conditioning unit in the air-conditioning mode to be gradually reduced until it shuts down completely (after eight hours).

To select "SLEEP" function, proceed as follows:

- Press the **POWER** button (I) to turn the appliance on.
- The symbol  flashes on the display and a "beep" indicates that the air-conditioning unit is on.
- Press the **MODE** button (A) a number of times until the symbol  of the function required appears on the display.
- Then select the required temperature by pressing the ▲ ▼ buttons.
- Now press the **SLEEP** button (F) to set the night function. The symbol  is displayed. With the "SLEEP" function activated, the fan operates at low speed.

On the control panel the indicator light (F) comes on.

Press the **SLEEP** button again to go back to the previous mode.

Note: The SLEEP function maintains the room temperature at the optimum level, avoiding excessive increases or drops in the temperature, with silent operation.

The flow of air decreases, while the room temperature varies gradually according to the comfort requirements: increases of approx. 2°F (approx. 1°C) after 60 minutes and approx. 4°F (approx. 2°C) after 2 hours (it switches off altogether after eight hours).

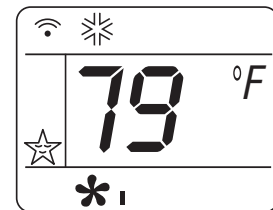

PROGRAMMING THE TIMER

The timer can be used to delay appliance start up or shut down. This avoids wasting electricity by optimizing operating periods.

Programming shut-down

- With the air-conditioning unit on, press the **TIMER** button (E). The time is displayed and the "h" symbol flashes. Set the time when you want the appliance to go off using the ▲ ▼ buttons (from 30 minutes to 24 hours). During the first ten hours, you can select half hour intervals. For times greater than ten hours, one hour intervals can be selected.
- Press the **TIMER** button again to confirm the selection. A count-down of the time left is displayed.
- At the end of the set time the appliance switches off automatically.
- To cancel the set time, press the **TIMER** button again. You will hear a "beep".

Programming start-up

- With the air-conditioning unit off, press the **TIMER** button (E). The time is displayed and the "h" symbol flashes. Set the time when you want the appliance to come on using the ▲ ▼ buttons (from 30 minutes to 24 hours). During the first ten hours, you can select half hour intervals. For times greater than ten hours, one hour intervals can be selected.
- Press the **TIMER** button again to confirm the selection.
- At the end of the set time the appliance switches on automatically.
- To cancel the set time, press the **TIMER** button again. You will hear a "beep".



Self diagnosis/Troubleshooting

SELF DIAGNOSIS

The appliance has a self diagnosis system to identify a number of malfunctions.

IF THE DISPLAY SHOWSWHAT SHOULD YOU DO?
LT LOW TEMPERATURE (frost prevention)	When LT appears on the display, the ice prevention device has been triggered. The appliance starts up again automatically when the defrosting process is completed.
PF PROBE FAILURE (sensor damaged)	If this is displayed, an authorized De'Longhi service center.
FT FULL TANK	Empty the tank on the back of the appliance and replace it correctly. The continuous drain hose is not connected correctly or is obstructed and the air conditioner is draining into the tank.
FI FAILURE 1	If this is displayed, contact an authorized De'Longhi service center.

TROUBLESHOOTING

PROBLEM	CAUSE	REMEDY
The air conditioning unit does not start	<ul style="list-style-type: none"> no electricity it is not plugged into the socket the safety device has tripped 	<ul style="list-style-type: none"> restore electricity plug into the socket reset the safety plug (see pag. 18)
The air conditioning unit works for a short time only	<ul style="list-style-type: none"> the air exhaust hose or the intake hose has a constriction the air exhaust hose or the intake hose is blocked there are tight bends in the air exhaust hose or the intake hose 	<ul style="list-style-type: none"> position the exhaust hose or the intake hose correctly check there are no obstacles obstructing air discharge or the intake hose eliminate the tight bends
The air conditioning unit works, but does not cool the room	<ul style="list-style-type: none"> windows are open there are heat sources in the room (lamp, etc). the exhaust hose is detached air filter is clogged Inadequate size of the room (too large) 	<ul style="list-style-type: none"> close the windows eliminate the heat source connect the exhaust hose clean or replace the filter
Particular odor in the room	<ul style="list-style-type: none"> air filter is clogged 	<ul style="list-style-type: none"> clean or replace the filter
The air conditioning unit does not operate for about three minutes after turning it on.	<ul style="list-style-type: none"> it is normal for the compressor to start after three minutes 	<ul style="list-style-type: none"> wait for three minutes
LT / PF / FT / FI appears on the display	<ul style="list-style-type: none"> See "Self-diagnosis" section 	

Tips

To get the best from your air conditioning unit, follow these recommendations:

- close the windows and doors in the room to be air conditioned.

The only exception is when the appliance is installed through a hole in the wall.

In this case, it is recommended to leave a door or window slightly open to guarantee correct ventilation.

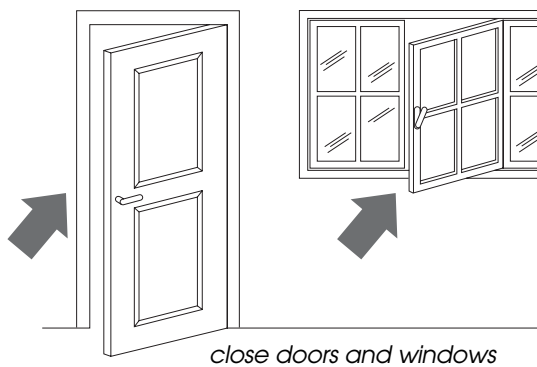

- Protect the room from direct exposure to the sun by partially closing curtains and/or blinds to make the appliance much more economical to run;
- Never rest objects of any kind on the air conditioning unit;
- Never obstruct the air intakes (6 and 7) or outlet (1) grilles;
- Make sure there are no heat sources in the room.

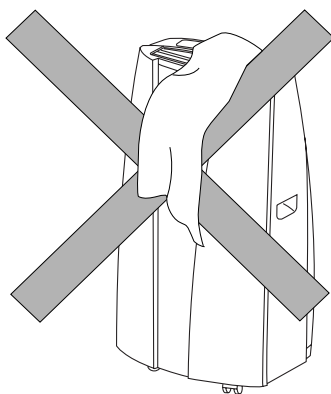

do not cover the appliance

- Never use the appliance in very damp rooms (laundry rooms for example).
- Never use the appliance outdoors.

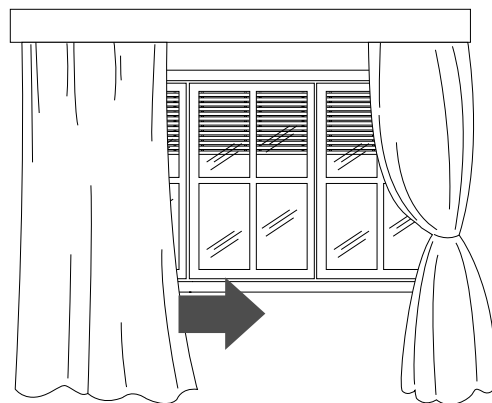

close blinds or curtains

- Make sure the air conditioning unit is on a **level** floor. If necessary, place the two castor locks (15) under the front castors (3).

3M® ELECTROSTATIC FILTER

To use the 3M® electrostatic filter, remove it from the packaging and attach it to the dust filter by inserting the two plastic edges on the 3M® filter onto the tabs on the dust filter (see figure).

Reposition the assembled filters in the grille and replace in the appliance.

When removing the evaporator air intake grille (7), do not touch the evaporator's metallic wings because they are very sharp and could be dangerous.

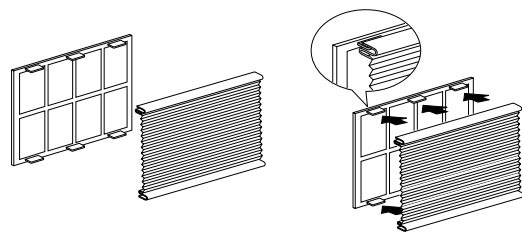

Cleaning and Maintenance

Before cleaning or maintaining, turn the appliance off by pressing the ON/STAND BY button (A) or button (I) on the remote control and always unplug the appliance from the socket.

CLEANING THE CABINET

You should clean the appliance with a slightly damp cloth then dry with a dry cloth. For safety reasons, never wash the air conditioning unit with water.

Precautions

Never use petrol, alcohol or solvents to clean the appliance.

Never spray insecticide liquids or similar.

CLEANING THE FILTERS

To keep your air conditioning unit working efficiently, you should clean the dust filter every week of operation.

The filter is housed in the intake grille.

When removing the evaporator air intake grille (7), do not touch the evaporator's metallic wings because they are very sharp and could be dangerous.

To clean the filters, proceed as follows

1. Remove the intake grille by rotating outwards (Fig. L).

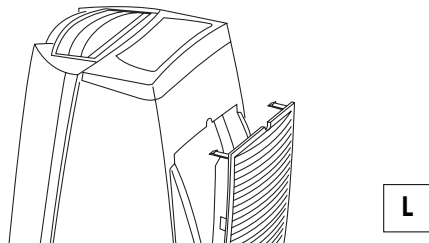

2. Remove the dust filter by detaching it from the grille (Fig. M). Remove 3M® electrostatic filter if it is mounted.

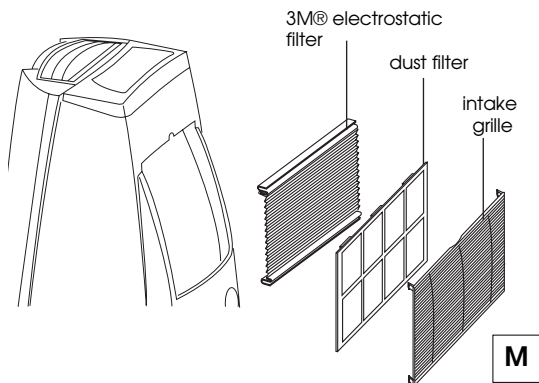

Use a vacuum cleaner to remove the dust collected on the filter.

If the dust filter is very dirty, immerse in warm water and rinse a number of times.

The water should never be hotter than 105 °F (40°C).

After washing, leave the filter to dry.

To replace, put the filters back in the intake grille then attach the intake grille to the appliance.

Do not wash the 3M® electrostatic filter when it is worn-out: change it with a new filter.

START OF SEASON CHECKS

Make sure the power cord and plug are undamaged and properly grounded.

Follow the installation instructions precisely.

END OF SEASON OPERATIONS

Place the appliance in stand-by.

To completely empty the internal circuit of water, press the **MODE** and **SPEED** buttons simultaneously for a few seconds without removing the condensation tank (8).

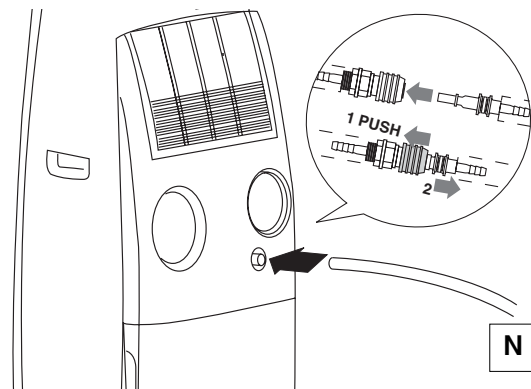

The water in the internal circuit will drain into the condensation tank (8) or through the continuous drain

hose (21) if connected (Fig. N)

Make sure the other end of the hose is near a suitable drain.

When completely drained, disconnect the continuous drain hose.

Clean the filters and dry thoroughly before putting them back.

Technical specification

LIMIT CONDITIONS	
Room temperature range of the air-conditioned space	64-95°F (18 - 35°C)

TECHNICAL SPECIFICATION

Power supply voltage	see rating plate
Max. power input during air conditioning	"
Refrigerant	"
Cooling capacity	"

Appliance dimensions:

• width	18.6 "	495 mm
• height	36.8 "	940 mm
• depth	16.1 "	410 mm
• weight	75 Lbs	34 kg

**Transport, filling, cleaning, recovery and disposal of refrigerant should be performed by a technical service center appointed by the manufacturer only.
The appliance should be disposed of by a specialist center appointed by the manufacturer only.**

**NEVER TURN THE APPLIANCE UPSIDE DOWN OR ON ITS SIDE.
IF THIS OCCURS, WAIT AT LEAST 8 HOURS BEFORE TURNING THE APPLIANCE ON.**

SAFETY PLUG

The appliance is fitted with a safety plug to protect the power cable.
If power is cut off, unplug from the mains and make sure the power cable is undamaged.
If the cable is damaged, contact an authorized De'Longhi service center immediately.
If power cuts off frequently and the power cable is undamaged, contact a qualified electrician.

OPERATION OF THE SAFETY PLUG

If the safety device incorporated in the plug trips and cuts off the power supply, check that the power cable and plug are not damaged.
If the power cable is undamaged, to restore operation press the "RESET" button.
To verify correct operation of the plug, press the "TEST" button periodically and make sure the appliance disconnects. If this is not the case, contact an authorized De'Longhi service center immediately. To restore operation, press the "RESET" button.

Limited Warranty

De'Longhi is the distributor of Kenwood home appliances.
This warranty applies to all home appliances with De'Longhi or Kenwood brand names.

FOR CONTIGUOUS UNITED STATES ONLY

Limited Warranty

We warrant each De'Longhi AIR CONDITIONER to be free from defects in material and workmanship. From the purchase date, our obligation under this warranty is to provide one (1) year free parts and labor on the entire AIR CONDITIONER, with an additional four (4) years free on any part of the sealed system consisting of the compressor, evaporator, condenser and factory connected refrigerant tubing. Labor and all other parts during the additional four (4) year warranty are to be paid by the owner. All AIR CONDITIONERS in need of repair are to be shipped to an authorized De'Longhi service center at the owner's expense, and De'Longhi will then incur the return shipping costs. After the first five (5) years of ownership, all expenses (all parts, labor and shipping) are to be paid by the owner of the unit. This warranty shall apply only if the AIR CONDITIONER is used in accordance with the factory directions that accompany it, and on an Alternating Current (AC) circuit. This warranty is in lieu of all other warranties and representations, expressed or implied, and all other obligations or liabilities on our part. We do not authorize any other person or company to assume for us any liability in connection with the sale or use of our AIR CONDITIONER. This warranty shall not apply to any AIR CONDITIONER that has been repaired or altered outside our factory nor shall it apply to any AIR CONDITIONER that has been subjected to misuse, negligence or accidents.

If repairs become necessary, see contact information below:

U.S. Residents:

Please contact our toll free hotline at 1-800-322-3848 or log onto our website at www.delonghi.com.

For all accessories, spare parts or replacement parts, please contact our parts division at 1-800-865-6330.

CANADA Residents:

Please contact our toll free hotline at 1-888-335-6644 or log onto our website at www.delonghi.com.

Other countries:

Please visit: www.delonghi.com.